

CHAIN COUNTER WIRING DIAGRAM SELECTION CHART

LEWMAR®

Contactor / Control Box	Sprint 1000	Sprint 1500	Sprint 3000A	A/man Power	Pacific V4000	Pacific V6000	V2, 3 & 5 / Concept1	V4 / Concept3
12V - 0052531	A	-	-	-	-	-	-	-
12V - 0052507	-	A	A	-	-	-	-	-
24V - 0052508	A	A	A	-	-	-	-	-
12V - 0052509	B	B	B	-	-	-	-	-
24V - 0052510	B	B	B	-	-	-	-	-
12V - 68000318	-	-	-	C	-	-	C	-
24V - 68000319	-	-	-	C	-	-	C	-
12V - 68000129	-	-	-	D	-	-	D	-
24V - 68000130	-	-	-	D	-	-	D	-
12V - 0052529	-	-	-	-	E	-	-	-
24V - 0052530	-	-	-	-	E	E	-	-
12V - 18000200	-	-	-	-	-	-	-	F
24V - 18000237	-	-	-	-	-	-	-	F
12V - 68000320	-	-	-	-	-	-	-	G
24V - 68000321	-	-	-	-	-	-	-	G

Pre 2004 & Custom Build Models

Can be used with all Lewmar custom windlasses, contact the sales office for a specific wiring diagram.

Sprint 900, Atlantic, Atlantic A, Atlantic C, AP700, AP1000 & AP1200 : Use Diagrams A* or B

Atlantic B & Concept / Ocean2 : Use Diagrams C or D - Sprint 3000 : Use Diagrams C or E

*Contactor 0052531 is NOT suitable for these products.

ELECTRIC
REMOTE
CONTROL
68000524



ELECTRIC
DECK SWITCH
69000016 - Up
69000017 - Down

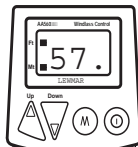
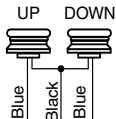

AA560

GUARDED
ROCKER
SWITCH
68000593

Refer to sensor splice
document for reed switch
connection details

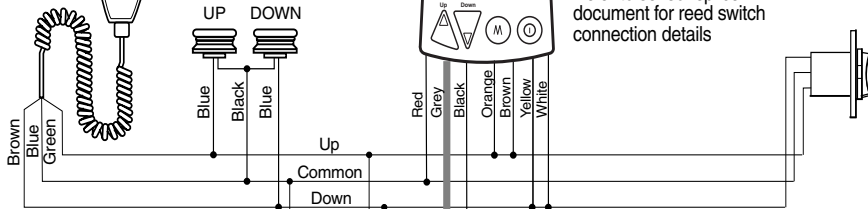

Grey Screened

Grey Sensor

Resettable
Breaker/
Switch 3A

CIRCUIT
BREAKER/ISOLATOR

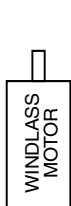

WINDLASS
MOTOR

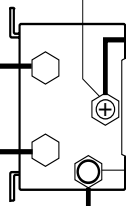

DUAL DIRECTION
CONTACTOR
12V - 0052507
24V - 0052508
12V - 0052531

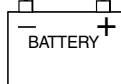

BATTERY

Diagram (A)

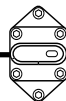

ELECTRIC
REMOTE
CONTROL
68000524

ELECTRIC
DECK SWITCH
69000016 - Up
69000017 - Down

AA560

GUARDED
ROCKER
SWITCH
68000593

Refer to sensor splice
document for reed switch
connection details

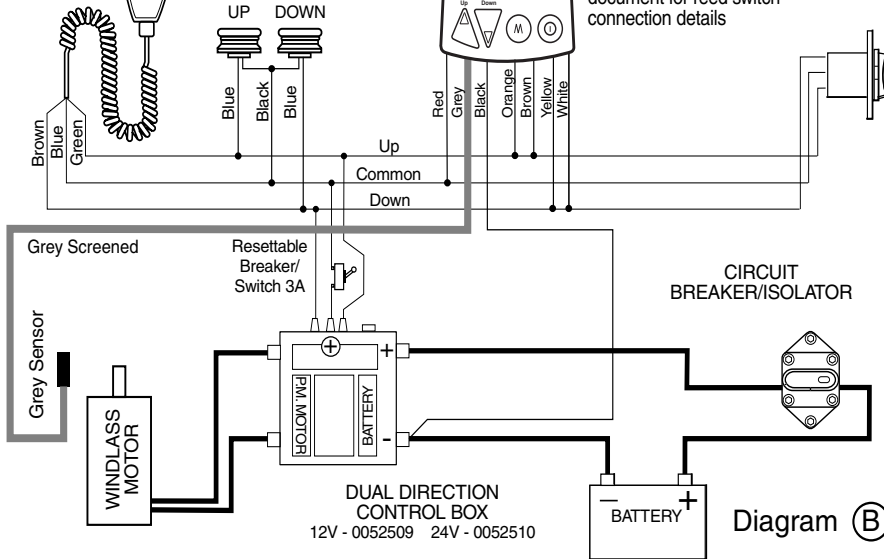

**ELECTRIC
REMOTE
CONTROL**
68000524



**ELECTRIC
DECK SWITCH**
69000016 - Up
69000017 - Down

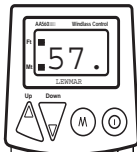

AA560

**GUARDED
ROCKER
SWITCH**
68000593

Refer to sensor splice
document for reed switch
connection details

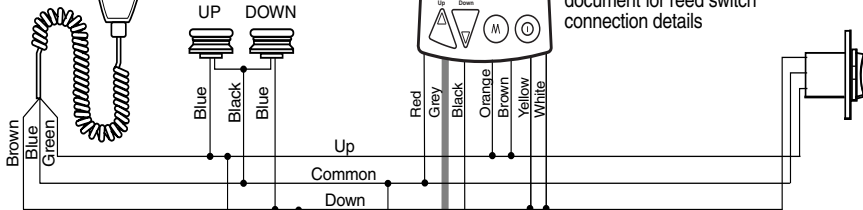

Grey Screened

Grey Sensor

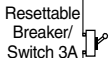

**CIRCUIT
BREAKER/ISOLATOR**

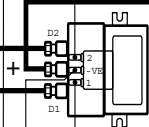
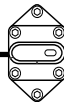

DUAL DIRECTION CONTACTOR
12V - 68000318 24V - 68000319

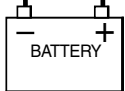
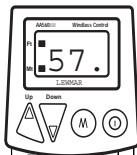

Diagram ©

ELECTRIC
REMOTE
CONTROL
68000524



ELECTRIC
DECK SWITCH
69000016 - Up
69000017 - Down



AA560

Refer to sensor splice
document for reed switch
connection details

GUARDED
ROCKER
SWITCH
68000593

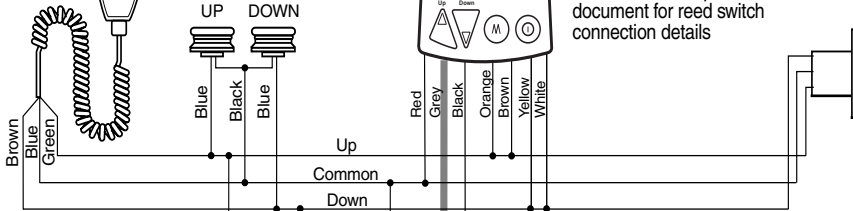

Grey Screened

Grey Sensor

Resettable
Breaker/
Switch 3A

CIRCUIT
BREAKER/ISOLATOR

WINDLASS
MOTOR
D2
D1
A2

DUAL DIRECTION
CONTROL BOX
12V - 68000129 24V - 68000130

BATTERY

Diagram **D**

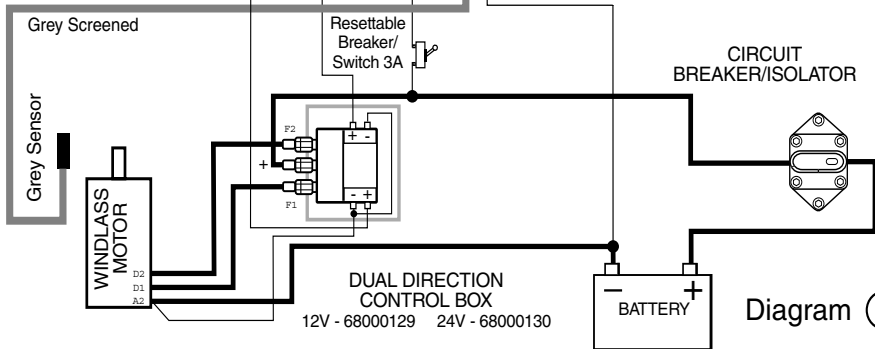

ELECTRIC
REMOTE
CONTROL
68000524



ELECTRIC
DECK SWITCH
69000016 - Up
69000017 - Down



UP DOWN
Blue Black Blue

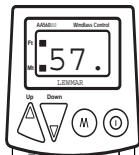

AA560

Refer to sensor splice
document for reed switch
connection details

GUARDED
ROCKER
SWITCH
68000593

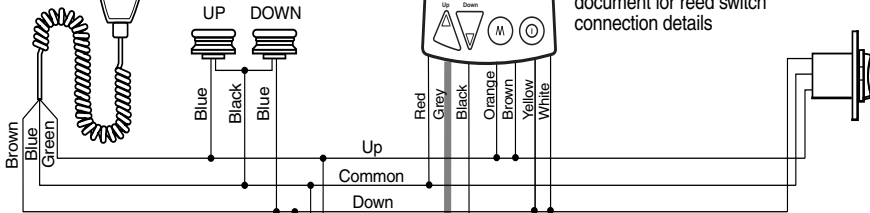

Grey Screened

Resettable
Breaker/
Switch 3A

CIRCUIT
BREAKER/ISOLATOR

Grey Sensor



WINDLASS
MOTOR

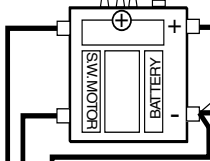

DUAL DIRECTION
CONTROL BOX
12V - 0052529 24V - 0052530

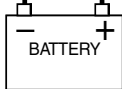

BATTERY

Diagram (E)

ELECTRIC
REMOTE
CONTROL
68000524



ELECTRIC
DECK SWITCH
69000016 - Up
69000017 - Down

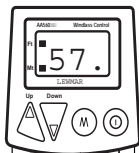

AA560

Refer to sensor splice
document for reed switch
connection details

GUARDED
ROCKER
SWITCH
68000593

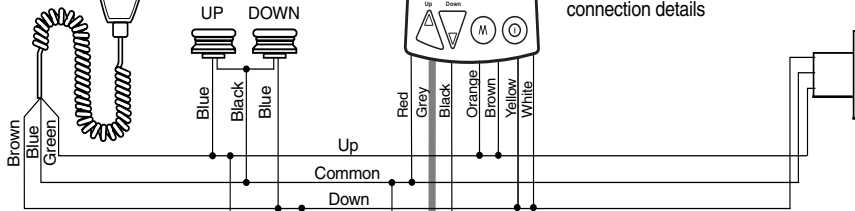

Grey Screened

Grey Sensor

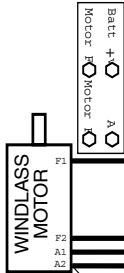

WINDLASS
MOTOR

Resettable
Breaker/
Switch 3A

CIRCUIT
BREAKER/ISOLATOR

DUAL DIRECTION
CONTROL BOX
12V - 18000200 24V - 18000237

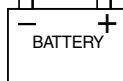
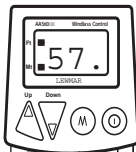

Diagram (F)

ELECTRIC
REMOTE
CONTROL
68000524



ELECTRIC
DECK SWITCH
69000016 - Up
69000017 - Down



AA560

GUARDED
ROCKER
SWITCH
68000593

Refer to sensor splice
document for reed switch
connection details

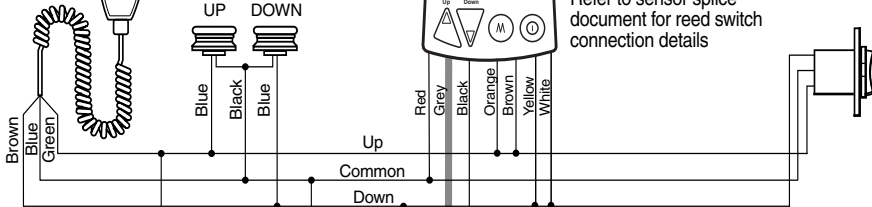

Grey Screened

Resettable
Breaker/
Switch 3A

CIRCUIT
BREAKER/ISOLATOR

Grey Sensor

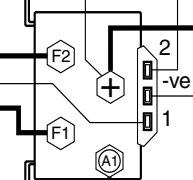

DUAL DIRECTION CONTACTOR
12V - 68000320 24V - 68000321

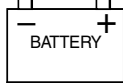

Diagram (G)